

THE GENERAL RADIO

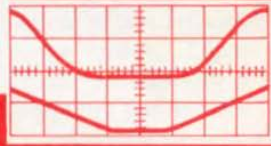

# Experimenter

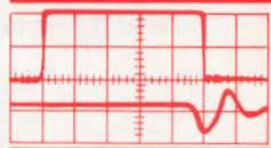
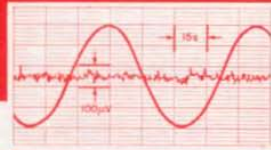

In this issue . . .

- ▶ Input Noise
- ▶ Type 1398-A  
Pulse Generator
- ▶ Type 1397-A  
Pulse Amplifier



VOLUME 40 • NUMBER 2 / FEBRUARY 1966



IET LABS, INC in the GenRad tradition  
534 Main Street, Westbury, NY 11590

TEL: (516) 334-5959 • (800) 899-8438 • FAX: (516) 334-5988

[www.ietlabs.com](http://www.ietlabs.com)

# the Experimenter

© 1966—General Radio Company, West Concord, Mass., USA

Published monthly by the General Radio Company

## THIS ISSUE

	Page
Input Noise .....	3
The Type 1398-A Pulse Generator .....	8
The Type 1397-A Pulse Amplifier .....	11

## GENERAL RADIO COMPANY

West Concord, Massachusetts 01781

\* NEW ENGLAND  
22 Baker Avenue  
West Concord, Massachusetts 01781

\* METROPOLITAN NEW YORK  
Broad Avenue at Linden  
Ridgefield, New Jersey 07657

PHILADELPHIA  
Fort Washington Industrial Park  
Fort Washington, Pennsylvania 19034

\* WASHINGTON and BALTIMORE  
11420 Rockville Pike  
Rockville, Maryland 20852

ORLANDO  
113 East Colonial Drive  
Orlando, Florida 32801

SYRACUSE  
Pickard Building, East Molloy Rd.  
Syracuse, New York 13211

CLEVELAND  
5579 Pearl Road  
Cleveland, Ohio 44129

\* CHICAGO  
6605 West North Avenue  
Oak Park, Illinois 60302

\* DALLAS  
2600 Stemmons Freeway, Suite 210  
Dallas, Texas 75207

\* LOS ANGELES  
1000 North Seward Street  
Los Angeles, California 90038

SAN FRANCISCO  
626 San Antonio Road  
Mountain View, California 94040

\* TORONTO  
99 Floral Parkway  
Toronto 15, Ontario, Canada

MONTREAL  
1255 Laird Boulevard  
Town of Mt. Royal, Quebec, Canada

\* Repair services are available at these offices

GENERAL RADIO COMPANY (OVERSEAS), 8008 Zurich, Switzerland  
GENERAL RADIO COMPANY (U.K.) LIMITED, Bourne End, Buckinghamshire, England

REPRESENTATIVES IN PRINCIPAL OVERSEAS COUNTRIES



# INPUT NOISE

## ITS INFLUENCE ON COUNTER AND PULSE-GENERATOR PERFORMANCE AND ITS MEASUREMENT

The significance of input noise in counters, pulse generators, and other broadband switching circuits and a method for its measurement are the subjects of the first of three short articles featured this month. The second and third articles describe a new pulse generator and amplifier, both designed for general-purpose laboratory applications.

In an externally driven pulse generator, noise introduced in the input circuit determines the amount of jitter in the output pulse; in a frequency counter, the input-circuit noise affects the accuracy of the instrument, particularly in low-frequency period measurements. Clearly, a knowledge of the input-noise characteristics of such instruments is essential to an understanding of their accuracy specifications.

Techniques for measuring input noise were devised at General Radio during the development of the TYPE 1151 Digital Time and Frequency Meter<sup>1</sup>, the only counter, as far as we know, that carries a direct input-noise specification. The same measurement techniques were applied to our pulse generators; Figure 1 is the result of such a measurement of our popular TYPE

<sup>1</sup>R. W. Frank, "Zero to 300 ke with Five-Digit Accuracy," *General Radio Experimenter*, June 1963.

1217-C Unit Pulse Generator. Inasmuch as we will specify input noise, where appropriate, for future instruments, we will explain in this short article how we make the measurements.

### The Significance of Input Noise

The operation of a typical input switching circuit is shown in Figure 2. This is the characteristic of a simple Schmitt trigger circuit, with the triggering and resetting points defining the hysteresis voltage region. Figure 3 magnifies the triggering point to show the area of uncertainty and to indicate how this area is influenced by noise on the triggering threshold and on the signal. It is apparent that the error in the time of triggering depends on the slope of the signal voltage and the magnitude of the noise. If a signal of

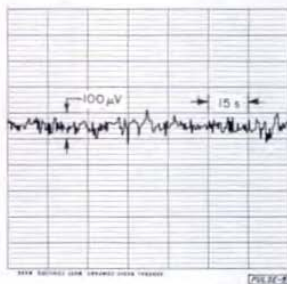

Figure 1. Noise of a Type 1217-C Unit Pulse Generator driven by a 2.05-V ramp with a 204.8555-millisecond period. The last three digits are recorded. One major division corresponds to 100  $\mu$ V, peak-to-peak, noise.



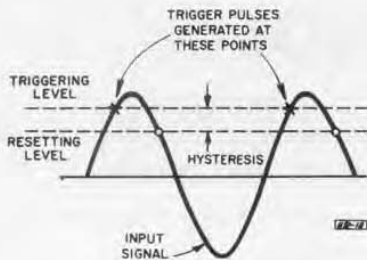

Figure 2. Operation of a typical input circuit.

precisely known period and very low noise is applied to a noisy threshold, the error in a period measurement will be as shown in Figure 4.

If the signal applied in Figure 4 were a sine wave, then the slope of the signal voltage would be the time derivative of the signal as it passes the triggering area. This leads to the familiar figures for period-measurement error due to signal-to-noise ratio. At zero crossings:

$$\Delta T = \pm \frac{1}{\pi} \frac{V_n}{V_s}$$

If triggering occurs not at the zero crossing but at an angle  $\theta$  in the input-voltage cycle, then:

$$\Delta T = \pm \frac{1}{\pi} \frac{V_n}{V_s} \frac{1}{\cos \theta}$$

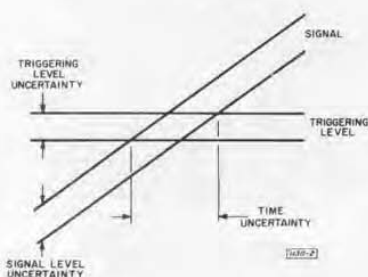

Figure 3. The effects of uncertainty in signal on triggering level.

In both the above equations,  $V_n/V_s$  is the noise-to-signal ratio. If this figure and the crossing angle are known, then the error in a period measurement can be determined. This is the basis for the accuracy specifications of most counters, with no assumptions made about where the noise  $V_n$  comes from. To make a valid measurement, the user must concern himself with two quantities: First, he must know the signal-to-noise ratio of the signal he is measuring; second, he must know the equivalent input noise of the measuring instrument.

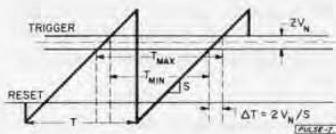

Figure 4. A periodic signal of slope  $S$  volts/second and period  $T$  traverses the hysteresis region with a superimposed noise signal of peak value  $V_n$ . By inspection it can be seen that the maximum time-interval fluctuation,  $\Delta T$ , will be  $\pm 2 V_n / V_s$ .

As an example of the practical implications of these factors, consider a single-period measurement of a 10-volt signal with an 80-dB signal-to-noise ratio. If the counter introduces more than 1 millivolt of noise (and most counters do), that noise, rather than the noise on the signal, will control the accuracy of measurement.

### Measuring Input Noise

The system used at General Radio for quantitative measurement of the performance of switching circuits is shown in Figure 5. The task that this system must perform can be deduced from Figure 4. It must produce a

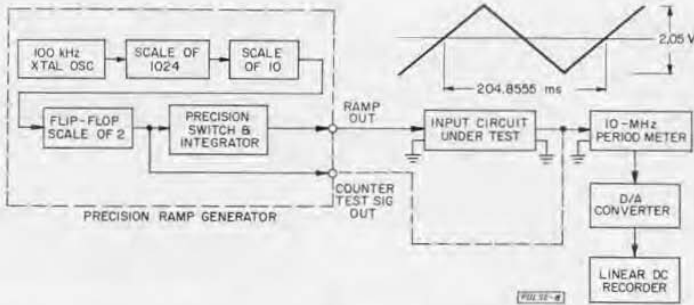

Figure 5. The precision ramp and the system for generating it. The quartz-crystal oscillator output is divided by 20,480 to produce a precise time interval. The crystal is set low in frequency by about 25 Hz to produce final period of 204.8555 milliseconds. Dc-coupled output is set to exactly 2.05 V, peak-to-peak, so the slope is nearly 20 V/s in both directions.

completely clean signal of exactly known period, feed this signal into the input circuit to be evaluated, and measure the fluctuations in period of the triggers produced. If very high signal-to-noise ratios are to be attained, frequency stability must be excellent; therefore the system uses a crystal oscillator. The reference signal is triangular; if it were sinusoidal, either a separate measurement would be necessary to determine that the input circuit was truly switching at zero crossing or corrections to the signal-to-noise figure for signal slope at different triggering levels would have to be made.

In the test setup shown, the ramp is highly linear, so that no corrections for phase are necessary. The ramp slope is symmetrical, so that the noise for both negative-going and positive-going threshold detectors can be evaluated.

The ramp has a period of 204.8555 milliseconds (the last digits chosen to place a plot at midscale on a strip chart) and an amplitude of 2.05 volts, or positive and negative slopes of 20 volts/second.

This ramp is fed to the input circuit

under test, and the period of the output triggers from the triggering circuit is measured on any 10-MHz period-measuring counter. In the complete absence of noise, the counter would indicate 204.8555 milliseconds. The left-hand digit corresponds to volts, the second to tenths of a volt, etc. Thus the final digits (555) correspond to hundreds, tens, and units of microvolts of noise. The  $\pm 1$  count error of the counter therefore corresponds to an ultimate system resolution of  $\pm 1 \mu\text{V}$ . The counter reading is fed through a D/A converter to a strip-chart recorder.

The big question, of course, is—how good is the ramp? For what we actually measure are time-interval fluctuations due to noise in the combination of the ramp and the input circuit under test.

A linear amplifier can be inserted between the ramp generator and the input circuit under test to increase the ramp slope. If the slope is increased by a factor of 10 (corresponding to 20 dB of inserted gain), the ramp-amplifier noise will quickly predominate over

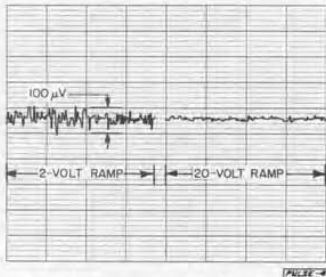

Figure 6. Noise measured (left) with test ramp applied directly to a Type 1217-C and (right) with low-noise amplifier inserted between ramp generator and a Type 1217-C.

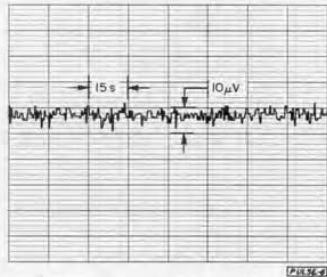

Figure 7. Performance of low-noise comparator with precision ramp. System noise appears to be about  $6 \mu\text{V}$ , peak-to-peak.

that of the input circuit alone. The ramp noise can then be measured, as long as the amplifier noise is negligible.

Figure 6 compares the input noise measurement of Figure 1 with a similar measurement made with a 20-dB low-noise amplifier inserted between ramp generator and input circuit. The sharp reduction in noise as the slope is increased by an order of magnitude is convincing proof that most of the noise is in the input circuit, not in the ramp-amplifier combination.

Figure 7 shows how the best balanced amplitude comparator<sup>2</sup> we have yet built (Figure 8) responds to the test

ramp. One would conclude from Figure 7 that the ramp-comparator combination has a peak-to-peak noise no worse than  $10 \mu\text{V}$  ( $3 \mu\text{V}$ , rms). The true rms value for any of these measurements can be either computed from the successive counter readings or measured with a low-frequency rms meter.

Again the question must occur: Is the primary contributor to this over-all noise the ramp or the comparator? With such a low-noise comparator, it is not possible to insert an amplifier with any assurance that its input noise is lower than that of the comparator.

<sup>2</sup> R. W. Frank, "How to Kill Time — Accurately!" *General Radio Experimenter*, December 1958, p 8.

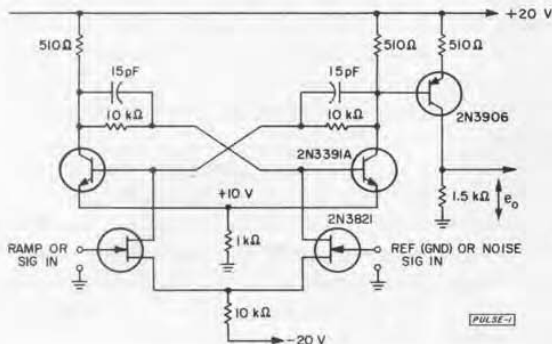

Figure 8. Schematic diagram of low-noise comparator. Balanced input circuit uses TI 2N3821 N-channel field-effect transistors. Hysteresis is 0.3 V at either gate. Comparator maintains constant hysteresis to over 500 kHz.



In Figure 9, the slope of the ramp itself is varied by changes in the value of the integrating capacitor. The lower value of integrating capacitor increases the ramp slope to 30 volts/second. In spite of the slightly higher effective impedance of the ramp generator, the over-all noise decreases. We must conclude that the predominant noise contribution is from the comparator.

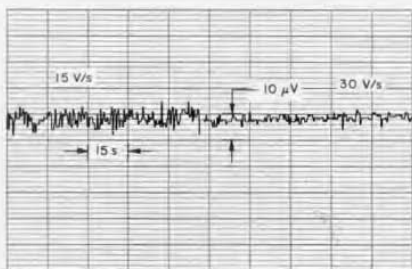
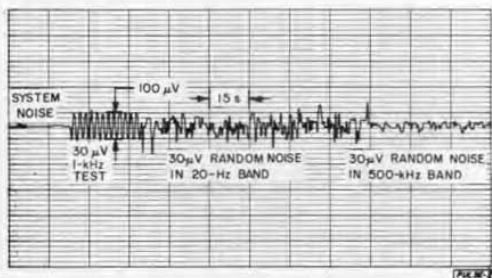

Figure 9. Performance of FET comparator as ramp slope is changed from 15 to 30 V/s.

In Figure 10, the trace begins showing the system noise of less than  $10 \mu\text{V}$ . A 1-kHz signal of  $30 \mu\text{V}$ , rms, amplitude is then injected into the comparator; finally,  $30 \mu\text{V}$  of noise at 20-kHz and 500-kHz bandwidths is applied for several minutes. Note that  $30 \mu\text{V}$  of noise in the 20-kHz band does occa-

Figure 10. Performance of the ramp-comparator system with various noise signals applied. Trace starts with 30 seconds with no noise signal. Then  $30 \mu\text{V}$ , rms, at 1kHz is applied for about 45 seconds, showing that the ramp slope is about correct and that one division equals  $100 \mu\text{V}$ , peak-to-peak. Then a Type 1390-B Random-Noise Generator provides  $30 \mu\text{V}$ , rms, of random noise in 20-kHz and 500-kHz bands. With the 500-kHz bandwidth, one would have to wait for a very long time for a full deviation error. Note the similarity of the noise generator trace to that showing system performance, an order of magnitude lower in level, in Figure 7.



Richard W. Frank, Group Leader in the GR Engineering Department served in the U. S. Navy from 1942 to 1945. After the war he attended the Massachusetts Institute of Technology, receiving his SB in electrical engineering in 1950 and his SM in 1951. He joined the GR engineering staff in 1951 as a development engineer, and since 1957 he has been head of the Frequency and Time Group.



sionally attain  $100 \mu\text{V}$ , peak-to-peak, amplitude but doesn't look like  $30 \mu\text{V}$  rms. With the 500-kHz bandwidth, the rms value of the noise looks even smaller. This proves that the comparator functions as a time-domain filter.

From such measurements we conclude that the input noise of a TYPE 1217-C Pulse Generator is about  $20 \mu\text{V}$ , that of the TYPE 1398-A about  $50 \mu\text{V}$ . Since most counters have noise figures probably in the 1-to-10-millivolt region, this means that the accuracy of a single-period measurement can be improved by more than an order of magnitude if a TYPE 1217-C or 1398-A Pulse Generator is used to trigger a counter.

— R. W. FRANK



Figure 1.

## THE TYPE 1398-A PULSE GENERATOR

An instrument, no matter how ingeniously designed and efficiently made, is never so good that it can't be improved. That is the story of GR's general-purpose pulse generator, which our engineers designed over 10 years ago and have not been able to leave alone since. Each successive model represented unequalled value for this class of instrument, and customer response has always been excellent. But the campaign continued to squeeze just a few more ounces of performance out of the design, while holding the cost in line.

The latest of these pulse generators, the TYPE 1398-A, is most easily described in terms of the popular TYPE 1217-C.<sup>1</sup> The new generator has a shorter rise time and more output power than the TYPE 1217-C and contains its own regulated power supplies. For those who don't need the faster pulse and the extra power and who have their own power supply, the TYPE 1217-C remains available.

To review the general specifications of the TYPES 1217-C and the 1398-A: In both, prf range is 2.5 Hz to 1.2 MHz and duration is 100 nanoseconds to 1 second. In the TYPE 1398-A, transition times have been dropped from 10 to 5 nanoseconds (see Figure 2), and output current has been boosted from 40 to 60 mA, so that the open-circuit output is 60 volts behind 1 kilohm.

<sup>1</sup> R. W. Frank, "Improved Performance from the Unit Pulse Generator," *General Radio Experimenter*, December 1964.

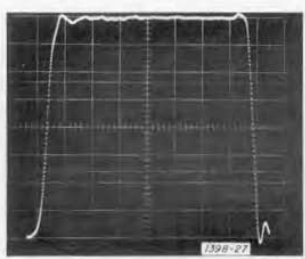

Figure 2. A positive output pulse shown at 10 ns/cm writing speed. The fall time is about 3 ns.

### Circuit

Figure 3 is a block diagram. In the timing and output circuits, vacuum tubes are used for their high input impedance and ruggedness; the pulse-control circuits are transistorized for maximum switching speed. In the TYPE



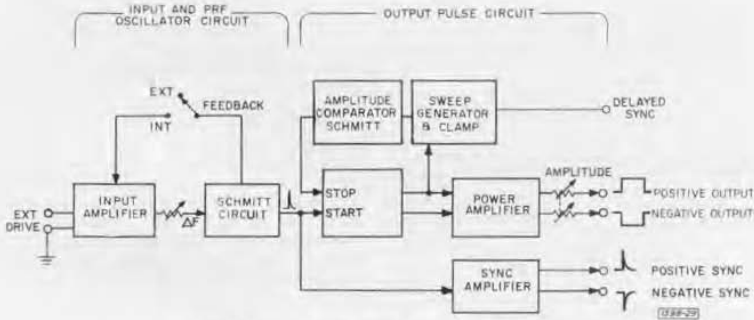

Figure 3. Block diagram of the pulse generator.

1398-A, new silicon npn transistors and double-frame-grid power output tubes further extend the capabilities of the hybrid arrangement.

The input circuits, shown in Figure 4, require only three active devices, which are switched into operation as either a prf oscillator or an aperiodic trigger circuit, depending on whether internal or external drive is desired. Equivalent input noise (as measured by the techniques described in the preceding article) is about 50  $\mu$ V, rms (see Figure 5), which is much lower than that of many trigger-type input systems. This low input noise leads to very low prf jitter with external drive.

The push-pull output circuit (Figures 6 and 7) offers many advantages: it presents a constant load to the power supply; it delivers both positive-going and negative-going pulses simultaneously; the pentodes used are linear current sources, which produce the same source impedance for either polarity; the output is short-circuitable, and there are no duty-ratio restrictions; and finally, since the output terminals are direct-coupled to the output stage plates, there is never any rampoff.

Another characteristic of this circuit is that it retains a dc component negative with respect to chassis ground. A feature of the new generator is provision

Figure 4. Schematic diagram of input circuits. Switched as shown, for external operation, the Schmitt circuit is driven by the input dc amplifier and is a fast 2-MHz-to-dc trigger circuit. When the PRF control is set for the internal mode, the same components are switched into a stable oscillator that can be injection-synchronized from the external-drive terminals. The input tube becomes a current source to translate the left-hand plate swing to center on the Schmitt circuit. The circuit oscillates within its hysteresis region. C1 establishes frequency range, R1 gives continuous frequency adjustment.

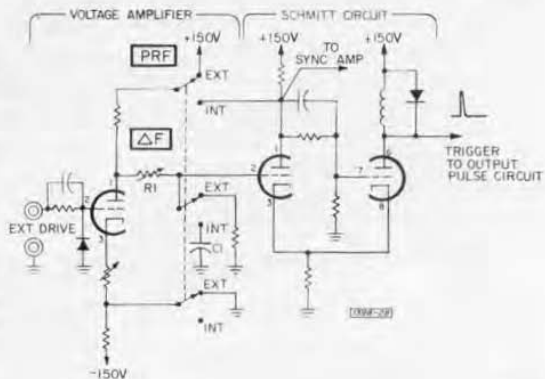

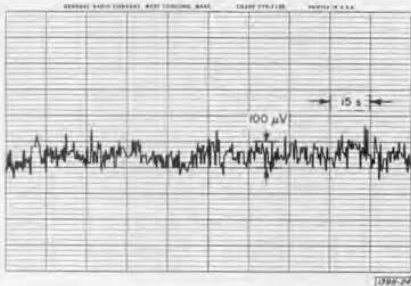

Figure 5. (Above) Plot showing noise generated in input circuit.

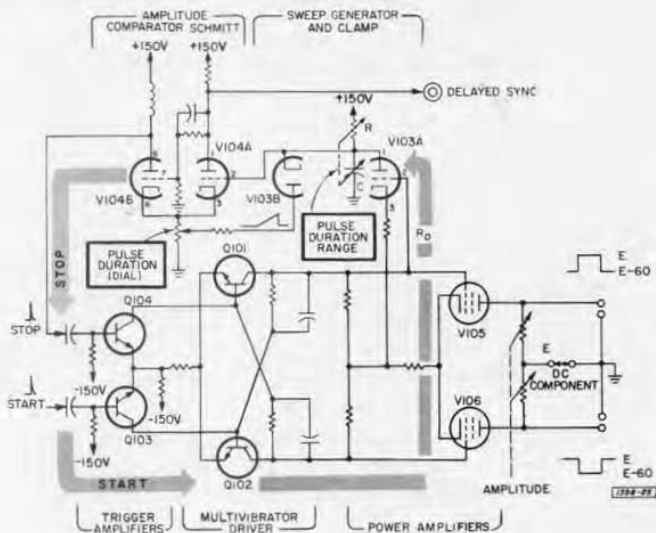

Figure 6. (Below) Schematic diagram of output and timing circuits. Q101 and Q102 comprise a transistor bistable circuit. Q101 is normally off and V105 and V103 normally on. Conduction of V103A keep V104A off, and timing potentiometer R125 establishes initial voltage on timing capacitor C. The active pulse interval is initiated by a start pulse, which turns Q101 on and Q102 off. V103 and V105 go off, V106 on. C charges through R to the triggering point of Schmitt comparator V104. Upon triggering, the Schmitt circuit resets the flip-flop, terminating the pulse.

for easy control of the dc component, over about a  $\pm 15$ -volt range, by use of an external low-voltage power supply. Connection of such a supply will permit bias levels to be accurately established for devices to be driven by the generator. In addition, signal-sensing circuits and a socket are included for connection

to a to-be-announced dc-component control unit, which will attach directly to the right-hand side of the generator. This unit will automatically control the average value or either peak value of the positive or negative pulse over a  $\pm 15$ -volt range.

#### ABRIDGED SPECIFICATIONS

**PRF:** 2.5 Hz to 1.2 MHz, internal; dc to 2.4 MHz, external.  
**Pulse Duration:** 100 ns to 1 s.  
**Rise and Fall Times:** 5 ns into 50 or 100  $\Omega$ .  
**Output:** 60 mA, positive and negative.

**Power Required:** 105 to 125, 195 to 235, or 210 to 250 volts, 50 to 60 Hz, 90 W.  
**Panel Dimensions:** 12  $\times$  5 $\frac{1}{4}$  inches (305  $\times$  135 mm).  
**Net Weight:** 14 $\frac{1}{2}$  lb (7 kg).

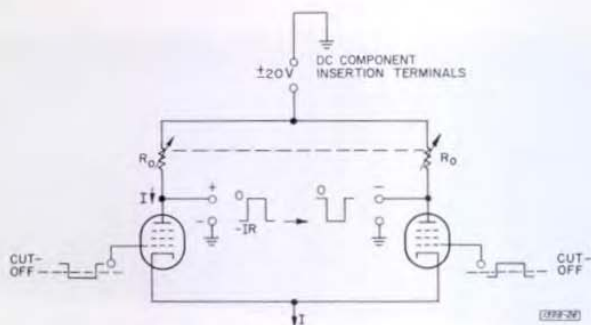

Figure 7. A closer look at the output circuit. The system includes a pair of switched current sources, V1 (normally on) and V2 (normally off). When the active pulse interval switches V1 off, the output voltage at the positive pulse terminal goes from  $-IR$  to 0, while the voltage at the negative terminal goes from 0 to  $-IR$ . Output impedance is adjusted to control open-circuit output voltage and is unaffected by switching circuits. The dc-component insertion terminals permit use of an external low-voltage power supply to translate the reference from 0 volts to the external supply voltage.

Catalog Number	Description	Price in USA
1398-9701	Type 1398-A Pulse Generator	\$535.00
0480-9632	Type 480-P312 Rack-Adaptor Set	6.50

U.S. Patent No. 2,548,457.

For complete specifications, see the current General Radio catalog or write to your nearest GR sales office.

## THE TYPE 1397-A PULSE AMPLIFIER

A new pulse amplifier, the TYPE 1397-A, has been designed as a companion not only for the TYPE 1398-A Pulse Generator described in this issue but for the TYPE 1217-C Unit Pulse Generator and the TYPE 1395-A Modular Pulse Generator<sup>1</sup> as well. The new amplifier increases the relatively low output power available from these instruments to a healthy 50 watts peak.

Why have pulse generator and pulse amplifier in separate packages, anyway? The separation, a long-standing

GR practice, makes excellent sense. Why, for instance, saddle a pulse generator with a costly and complicated high-power amplifier if the generator is most often used to drive the base of a transistor? The cost of such overkill is measured in performance as well as dollars. A 1-ampere generator not only will generally cost more than twice as much as, say, a TYPE 1217-C with power supply but also will have a duration limit of about 10 milliseconds compared with the 1-second maximum of the lower-cost pulse source. Moreover, since few generators producing an

<sup>1</sup> Gordon R. Partridge, "Pulses to Order," *General Radio Experimenter*, May 1965.





Figure 1. Type 1397-A Pulse Amplifier.

ampere can produce it continuously (another problem in economics), there must be duty-ratio restrictions, overload protection, etc.

The separation of generator and

amplifier offers some important design advantages, too. The new pulse amplifier is unique, for example, as a very nearly linear amplifier capable of amplifying complex waveforms. This useful

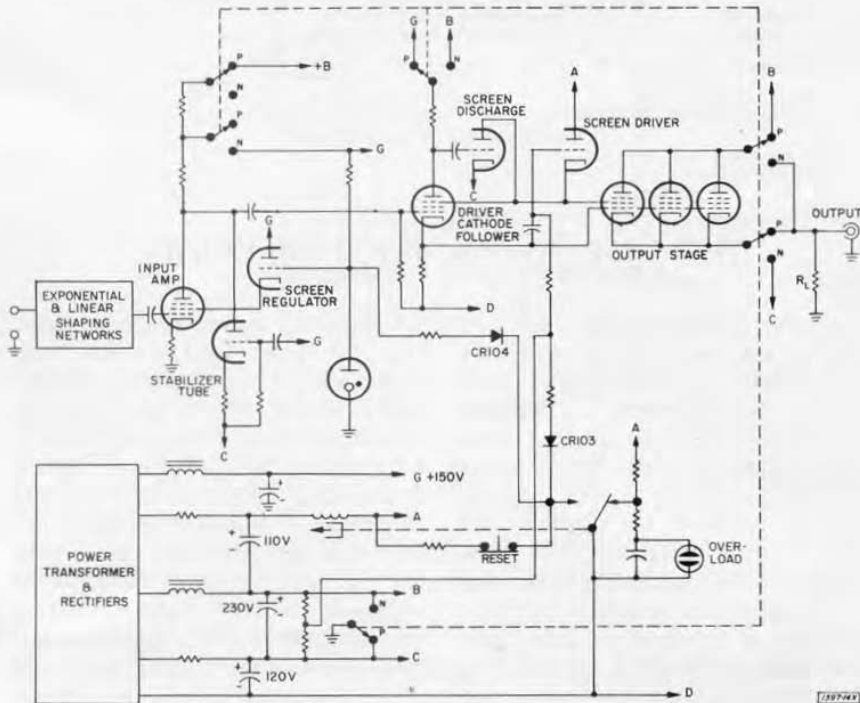

Figure 2. Elementary circuit diagram of the pulse amplifier.

characteristic would hardly be appropriate in the usual 1-ampere pulse generator, where the output stage is just a big, fast switch.

Having established the case for separate units, let us turn to the amplifier at hand. It needs only a 2-volt negative pulse at the input to produce a 1-ampere positive or negative output pulse. Rise and fall times are typically 40 nanoseconds (Figure 3), assuming the driver can get under 20 nanoseconds. Another useful feature is a variable-transition-time mode, which offers the user continuous adjustment of rise and fall times from 0.1 to 100 microseconds.

The output pulse can be either terminated in internal loads or coupled, without internal loss, to an external load. A single switch is used to select output polarity and load configuration.

Since the amplifier is substantially linear (Figure 9), it is a simple matter

to control output rise time by controlling the input pulse (Figures 11, 12). An input control does this, switching in a 100-ohm or 100-kilohm resistor, for minimum rise time (normal mode), or a set of simple networks to shape the input pulse into either an exponentially or linearly rising function over a range from about 0.1 to 100 microseconds.

The maximum duty ratio for the amplifier is 1/10. If this is exceeded, internal voltages are automatically switched off and a flashing lamp on the front panel calls for a manual reset.

#### Circuit

The straightforward circuit is shown in Figure 2. The input shaping networks are followed by a voltage amplifier, a cathode follower, and the output stage, consisting of three parallel-connected pentodes. These are connected as cathode followers for positive output pulses, as amplifier-inverters for negative output pulses. The changes in gain

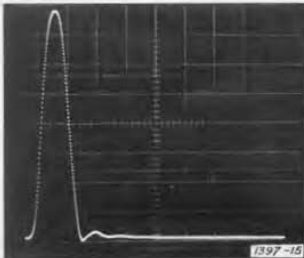

Figure 3. (Left) A 0.08- $\mu$ s input pulse from a Type 1217-C is amplified to 1.2 amperes in a 50-ohm system. Amplifier displays rise and fall times of about 0.04  $\mu$ s and about 5% overshoot on trailing transition. Oscilloscope is Tektronix 661-A at 0.1  $\mu$ s/cm.

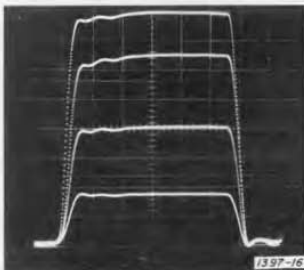

Figure 5. (Right) The 0.6- $\mu$ s pulse from the Type 1217-C is passed by the amplifier set for negative output. Note minimal ringing and clean transitions.

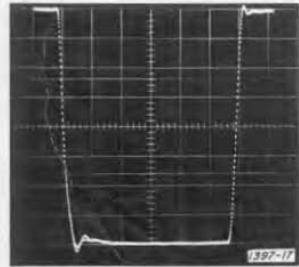

Figure 4. (Left) The positive pulse duration is increased to 0.6  $\mu$ s, and the driving pulse amplitude is decreased in three steps from full 1.2 amperes to about 80%, 50%, and 20% of initial level. Note slight changes in transient response. Small undershoot at positive peak flattens to small overshoot at 20% level.

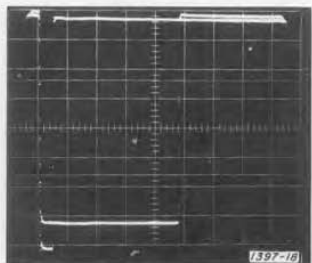

Figure 6. (Left) Effects of duty ratio on output pulse. PRF is 10 kHz and duration of shorter pulse is 1  $\mu$ s. When the Type 1217-C is switched to produce a 10- $\mu$ s pulse, the 10% duty ratio lowers the pulse amplitude to about 92% of the initial level. Note that pulses still retain excellent shape.

Figure 7. (Right) Still longer pulses. With duration increased to 100  $\mu$ s, no defects show in either positive or negative pulse. Oscilloscope is now a Tektronix 551. The Type 1217-C is still driving the amplifier in this double exposure.

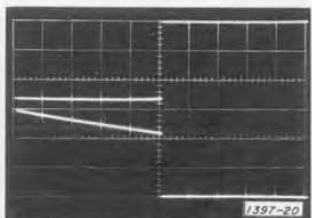
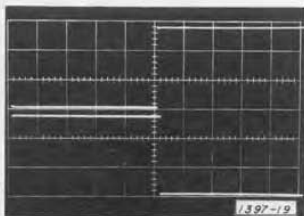

Figure 8. (Left) At the slowest writing rate, 1 ms/cm, a practically flat-topped negative pulse is seen just starting to roll down at 4 ms. It will fall more rapidly from here on. The positive pulse falls linearly, is down by 30% at 5 ms.

Figure 9. (Right) The story on linearity. We're indebted to the Type 1395-P3 Pulse Shaper for the beautifully linear ramp on top. This is the input to the Type 1397-A. The lower trace is the output, at full 1.2-A power. (The amplifier is set to invert the negative input pulse.) Transfer function shows lower gain at very low and very high power level as pulse starts from cutoff and rises into grid-current regions of output stage.

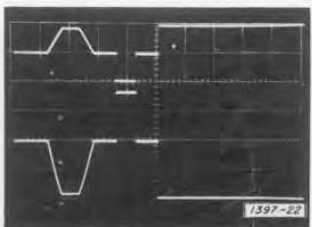
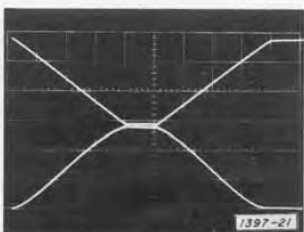

Figure 10. (Left) More linearity. The Type 1395-A Modular Pulse Generator provides a distinctive pulse to amplify (top), and the Type 1397-A gives a reasonable facsimile at a 1-ampere level.

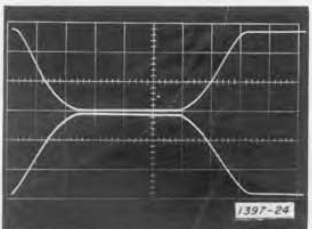

Figure 11. (Right) Positive and negative 10- $\mu$ s output pulses with rise-time controls set for exponentially rising pulse.

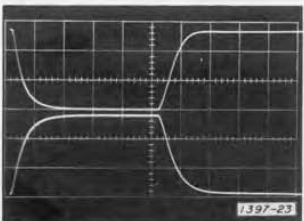

Figure 12. (Left) Positive and negative 10- $\mu$ s pulses with controls set for linearly rising pulse show 2- $\mu$ s rise times. They again display the transfer function of Figure 9, should be useful in driving magnetic structures at slower transition rates.



due to the different output configurations are compensated for by plate-load switching at the input amplifier.

So that the base of either positive or negative output pulse can be grounded while the pulses retain their dc component, the power supply for the entire output system is switched along with output polarity. The power supply for the input-amplifier stage is not switched, so that the grid-cathode

signal voltage is always developed with respect to ground.

#### Performance

Oscilloscopic comparison of input and output signals is the most objective evidence of an amplifier's capabilities. The unretouched oscillograms of Figures 3 through 12 show what the Type 1397-A can do under a variety of operating conditions.

### ABRIDGED SPECIFICATIONS

Mode	Input Impedance	Drive Required	Rise and Fall Times
NORMAL	100 $\Omega$ or 100 k $\Omega$ shunted by approx 50 pF, switch selected	- 2 V, p-to-p, minimum	< 50 ns (typically 30 ns) with input rise and fall times of < 20 ns
VARIABLE Linear	30 k $\Omega$ , approx	- 30 V, p-to-p, approx, minimum	0.1 to 100 $\mu$ s, approx, linear, continuously adjustable
Exponential	100 $\Omega$	- 2 to - 4 V, p-to-p, approx	0.1 to 100 $\mu$ s, approx, exponential, continuously adjustable

#### OUTPUT

**Rampoff:** Approx 20% with 5-ms pulse duration.

**Amplitude:** 1.2 A, p-to-p, max (60 V into 50  $\Omega$ ), 1 A, p-to-p, with 10% duty ratio. Automatic overload protector with manual reset.

**Amplitude Variation:**  $\pm 10\%$  for duty-ratio changes from minimum to 10%. With  $\pm 10\%$  line-voltage changes, positive variation is  $\pm 10\%$ , negative output is  $\pm 5\%$ .

**Internal Shunt:** Positive output, 50  $\Omega$  or open circuit; negative output, 50  $\Omega$ , 100  $\Omega$ , or open circuit.

#### GENERAL

**Max Duty Ratio:** 10%.

**Power Required:** 105 to 125, 195 to 235, or 210 to 250 V, 50 to 60 Hz, 100 W.

**Panel Dimensions:** 14  $\times$  5 $\frac{7}{8}$  inches (355  $\times$  150 mm).

**Net Weight:** 18 lb (8.5 kg).

Catalog Number	Description	Price in USA
1397-9701	Type 1397-A Pulse Amplifier	\$495.00
0480-9634	Type 480-P314 Rack-Adaptor Set	6.00

U.S. Patent No. 2,548,457.

*For complete specifications, see the current General Radio catalog or write to your nearest GR sales office.*

Among the first shipments of instruments during the war was a number of precision air capacitors. One of these found its way to an Army laboratory in France, where Lieutenant E. H. Armstrong was experimenting on a new circuit to improve the performance of radio receivers. He appropriated the capacitor, his new circuit was a sensational success, and thus one of the Company's earliest products was incorporated in the first superheterodyne receiver in 1917.

*(from A History of the General Radio Company)*

## INDEXES, BINDERS, HISTORIES OFFERED

### INDEX

The 1965 *Experimenter* index is now available and will be mailed free of charge to those requesting it. The index lists all articles published during the year and is arranged by subject, author, and instrument type number.

A small quantity of indexes for other years is also available. If you would like to round out a collection, perhaps we can help you.

### BINDERS

You can also obtain a binder for your *Experimenter* simply for the asking.

Each binder will hold about two years' *Experimenter*s.

### HISTORY

The *General Radio Company 1915-1965* is the title of a 32-page monograph written by Dr. Donald B. Sinclair, GR president, and available (while the supply lasts) to *Experimenter* readers on request. The short history, presented at a meeting of The Newcomen Society, tells of the people and philosophies that helped make GR, and, in a sense, the electronics industry, grow.

---

DO WE HAVE YOUR CORRECT NAME AND ADDRESS — name, company or organization, department, street or P.O. box, city, state, and zip code? If not, please clip the address label on this issue and return it to us with corrections, or if you prefer, write us; a postcard will do.

PRINTED  
IN  
U.S.A.

---

the  Experimenters

**GENERAL RADIO COMPANY**  
WEST CONCORD, MASSACHUSETTS • USA

RETURN REQUESTED



**IET LABS, INC** in the **GenRad** tradition

534 Main Street, Westbury, NY 11590

TEL: (516) 334-5959 • (800) 899-8438 • FAX: (516) 334-5988

www.ietlabs.com